

DLC Display Co., Limited

德爾西顯示器有限公司



MODEL No: DLC0350ACP06RF-C-3

TEL: 86-755-86029824

FAX: 86-755-86029827

E-MAIL: sales@dlcdisplay.com

WEB: www.dlcdisplay.com



Record of Revision

Date	Revision No.	Summary
2021-06-10	1.0	Rev 1.0 was issued

1. Scope

This data sheet is to introduce the specification of DLC0350ACP06RF-C-3 active matrix TFT module. It is composed of a color TFT-LCD panel, driver ICs, FPC, CTP and a backlight unit. The 3.5" display area contains 320(RGB) x 240 pixels.

2. Application

Digital equipments which need color display, mobile navigator/video systems.

3. General Information

Item	Contents	Unit
Size	3.5	inch
Resolution	320(RGB) x 240	/
Interface	24bit RGB	/
Technology type	IPS	/
Pixel Configuration	RGB stripes	
Outline Dimension (W x H x D)	76.95 x 63.95 x 4.73	mm
Active Area	70.08 x 52.56	mm
Display Mode	Transmissive	/
View Direction	ALL	/
Display Driver IC	ST7272A	/
Touch Driver IC	FT5446	/
Backlight Type	LED	/
Weight	TBD	g

4. Outline Drawing

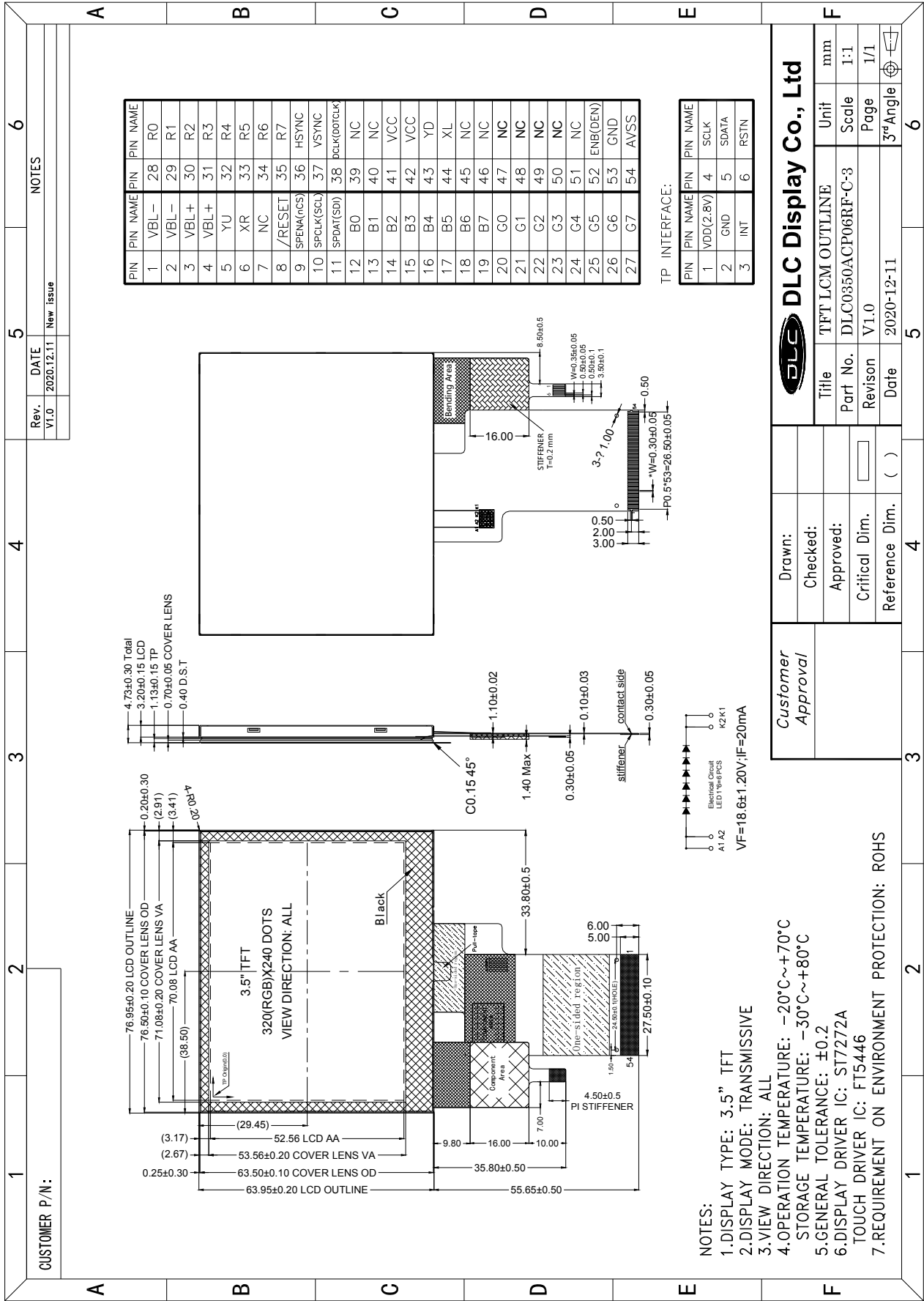

5. Interface signals

5.1 LCD PIN Definition

NO.	SYMBOL	DISCRIPTION	REMARK
1~2	VBL-	Cathode of backlight LED	
3~4	VBL+	Anode of backlight LED	
5	YU	Touch panel pin (No connection)	
6	XR	Touch panel pin (No connection)	
7	NC	No connection	
8	RESET	System Reset	
9	SPENA(nCS)	Serial data enable signal	
10	SPCLK(SCL)	Serial clock signal	
11	SPDAT(SDI)	Serial data signal	
12~19	B0~B7	Blue data	
20~27	G0~G7	Green data	
28~35	R0~R7	Red data	
36	HSYNC	Line synchronization signal	
37	VSYNC	Frame synchronization signal	
38	DCLK	DOTCLK	
39~40	NC	No connection	
41	VCC	Power supply	
42	VCC	Power supply	
43	YD	Touch panel pin (No connection)	
44	XL	Touch panel pin (No connection)	
45~51	NC	No connection	
52	ENB(DEN)	Display enable pin from controller	
53	GND	Power GND	
54	AVSS	Power GND	

5.2 TP PIN Definition

NO.	SYMBOL	DISCRIPTION	REMARK
1	VDD(2.8V)	Power supply (2.8V)	
2	GND	Ground	
3	INT	Interrupt output pin	
4	SCLK	Clock for the data input	
5	SDATA	Data input	
6	RSTN	Reset pin	

6. Absolute maximum Ratings

6.1. Electrical Absolute max. ratings

Parameter	Symbol	Min.	Max.	Unit	Remark
LCD Power supply	VCC	-0.3	4.0	V	Note1,2
	VIN	-0.3	VCC+0.3	V	

Note1: The ST7272A may be permanently damaged if it is used under the condition exceeding the above absolute maximum values. It is also recommended to use the ST7272A within the limit of its electric characteristics during normal operation. Exceeding the conditions may lead to malfunction of ST7272A and affect its credibility.

Note2: The voltage from VSS.

6.2. Environment Conditions

Item	Symbol	MIN	MAX	Unit	Remark
Operating Temperature	TOPR	-20	70	°C	
Storage Temperature	TSTG	-30	80	°C	

7. Electrical Specifications

7.1 Electrical characteristics

GND=0V, Ta=25°C

Item	Symbol	MIN	TYP	MAX	Unit	Remark
Power supply voltage for logic	VCC	3.0	3.3	3.6	V	
Input voltage	“L” level	VIL	GND	--	0.2*VCC	VCC=3.0~3.6V
	“H” level	VIH	0.7*VCC	--	VCC	

7.2 LED Backlight

Item	Symbol	MIN	TYP	MAX	Unit	Remark
LED Forward Current	IF	--	20	--	mA	
LED Forward Voltage	VF	17.4	18.6	19.8	V	IF=20mA
LED lifetime	--	--	30,000	--	Hr	IF=20mA

Note: The “LED life time” is defined as the module brightness decrease to 50% original brightness at Ta=25°C and IL =20mA. The LED lifetime could be decreased if operating IL is larger than 20mA.

7.3 Block Diagram of LCM

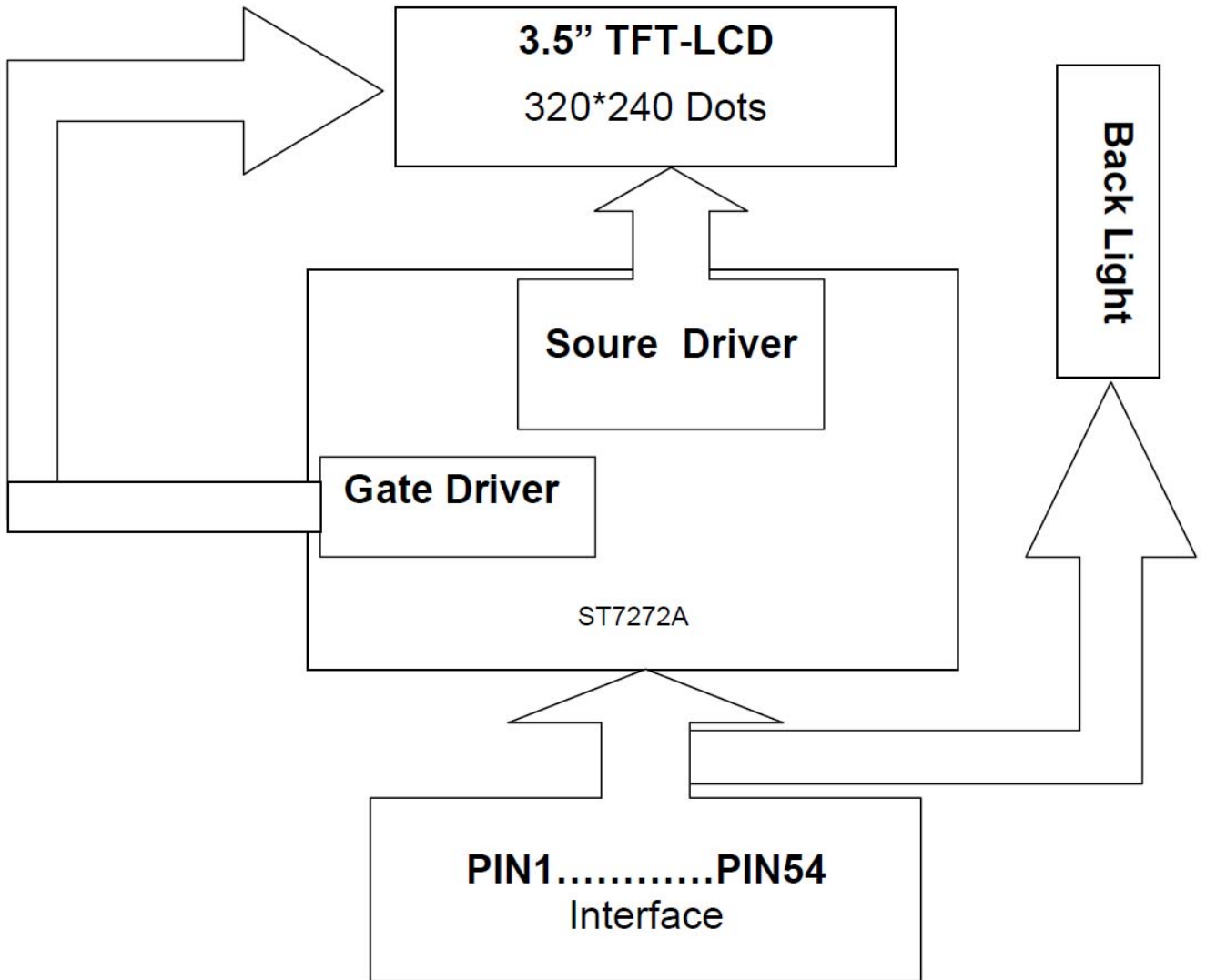

8. Command/AC Timing

8.1 Timing Characteristics

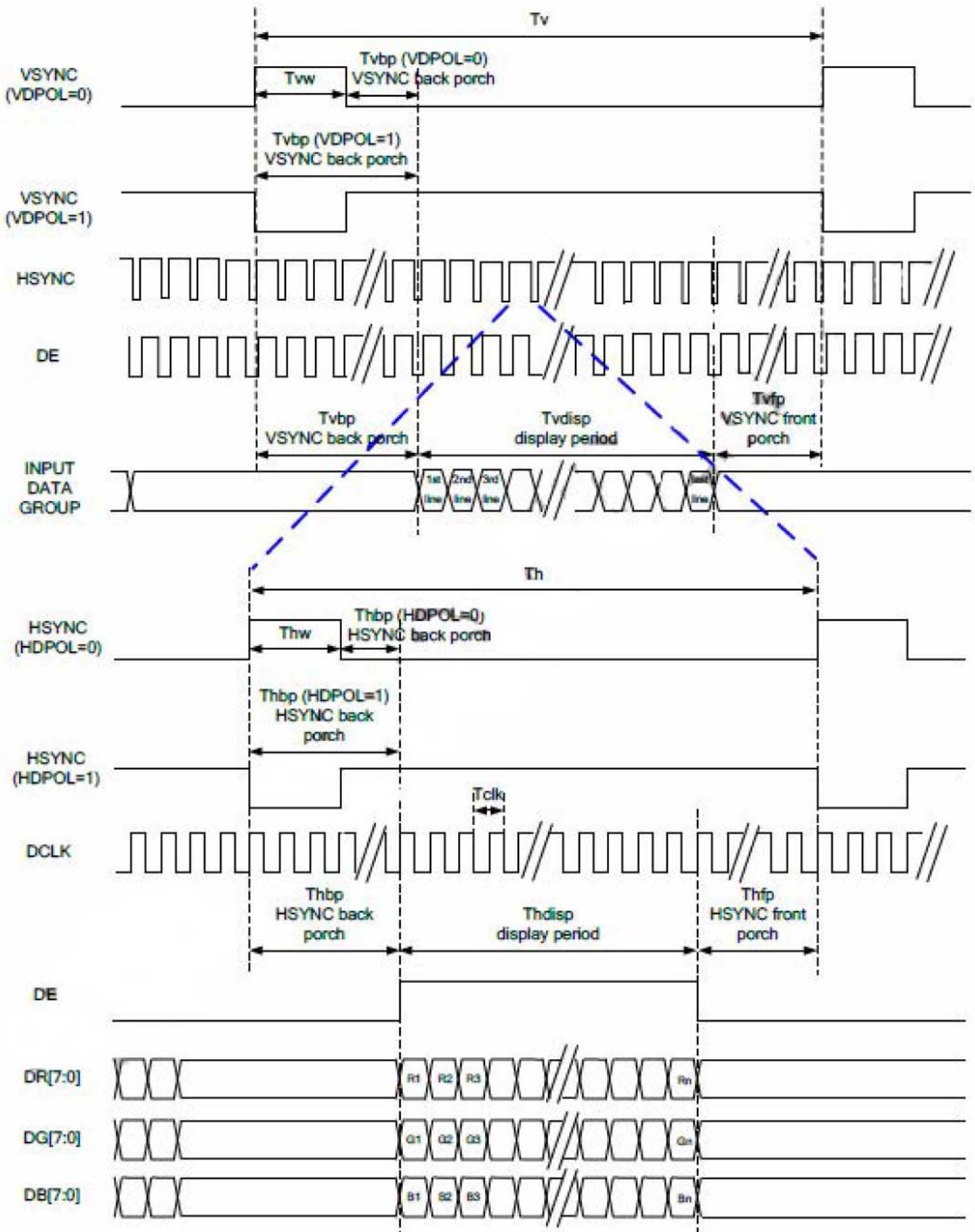

Parallel 24-bit RGB Input Timing (PVDD=VDD=VDDI=3.3V, AGND=0V, Ta=25°C)

Parallel 24-bit RGB Input Timing Table							
Item	Symbol	Min.	Typ.	Max.	Unit	Note	
DCLK Frequency	fclk	5	6	8	MHz		
DCLK Period	tclk	125	167	200	ns		
HSYNC	Period Time	th	325	371	438	DCLK	
	Display Period	thdisp	-	320	-	DCLK	
	Back Porch	thbp	3	43	43	DCLK	SYNC mode back porch control by H_BLANKING[7:0] setting thbp=H_BLANKING[7:0]
	Front Porch	thfp	2	8	75	DCLK	
	Pulse Width	thw	2	4	43	DCLK	
VSYNC	Period Time	tv	244	260	289	HSYNC	
	Display Period	tvdisp	-	240	-	HSYNC	
	Back Porch	tvbp	2	12	12	HSYNC	SYNC mode back porch control by V_BLANKING[7:0] setting tvbp=V_BLANKING[7:0]
	Front Porch	tvfp	2	8	37	HSYNC	
	Pulse Width	tw	2	4	12	HSYNC	

Note: It is necessary to keep tvbp=12 and thbp=43 in SYNC mode. DE mode is unnecessary to keep it.

9. Optical Specification

Ta=25°C

Item	Symbol	Condition	Min	Typ.	Max.	Unit	Remark
Contrast Ratio	CR	$\theta=0^\circ$	640	800	-		Note1 Note2
Response Time	Tr+Tf	25°C	-	30	40	ms	Note1 Note3
View Angles	θT	CR \geq 10	70	80	-	Degree	Note 4
	θB		70	80	-		
	θL		70	80	-		
	θR		70	80	-		
Chromaticity	White	Brightness is on	x	0.297	0.317	0.337	Note5, Note1
			y	0.319	0.339	0.359	
	Red		x	0.626	0.646	0.666	
			y	0.312	0.332	0.352	
	Green		x	0.303	0.323	0.343	
			y	0.547	0.567	0.587	
	Blue		x	0.114	0.134	0.154	
			y	0.101	0.121	0.141	
Luminance	L		--	380	--	cd/m ²	Note1 Note6
Uniformity	U		80	--	--	%	Note1 Note7

Note 1: Definition of optical measurement system.

Temperature = 25°C(±3°C); LED back-light: ON, Environment brightness < 150 lx

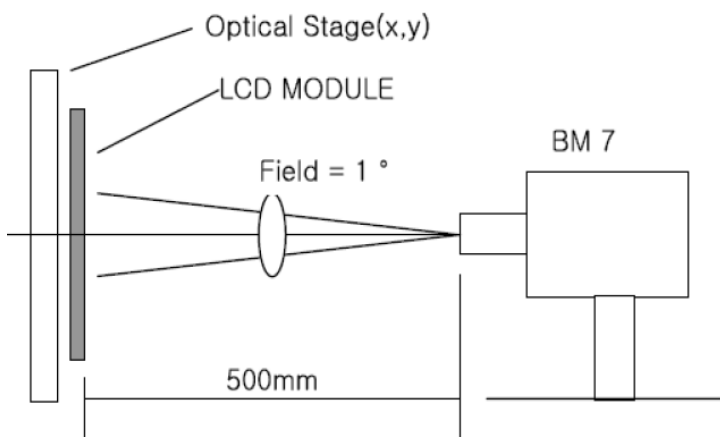

Note 2: Contrast ratio is defined as follow:

$$\text{Contrast Ratio} = \frac{\text{Surface Luminance with all white pixels}}{\text{Surface Luminance with all black pixels}}$$

Note 3: Response time is defined as follow:

Response time is the time required for the display to transition from black to white (Rise Time, Tr) and from

white to black(Decay Time, Tf).

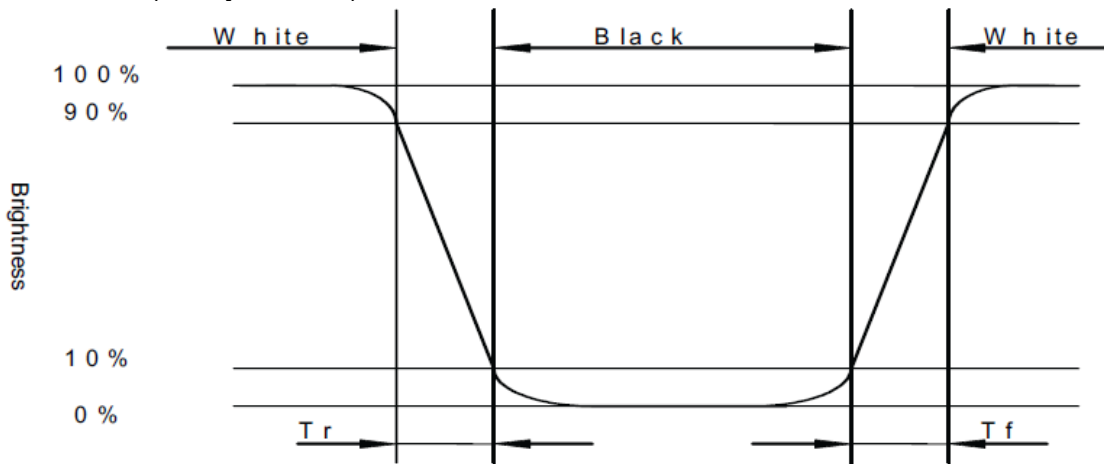

Note 4: Viewing angle range is defined as follow:

Viewing angle is measured at the center point of the LCD.

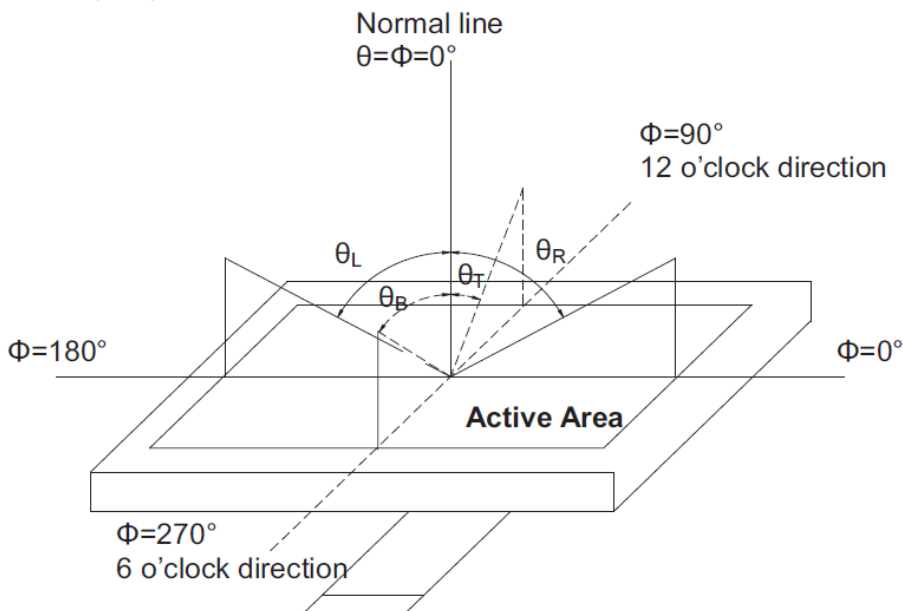

Note 5: Color chromaticity is defined as follow: (CIE1931)

Color coordinates measured at center point of LCD.

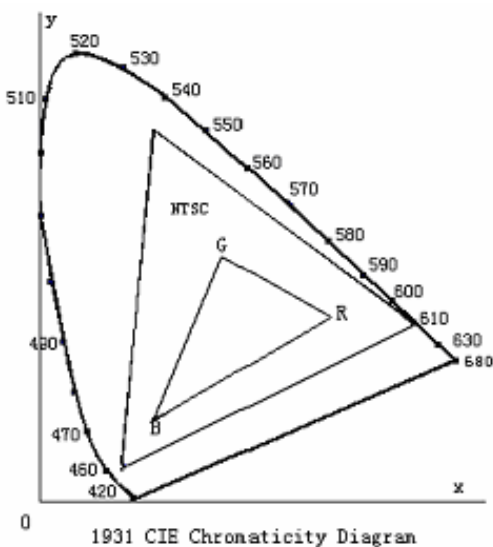

$$S = \frac{\text{area of RGB triangle}}{\text{area of NTSC triangle}} \times 100\%$$

Note 6: Luminance is defined as follow:

Luminance is defined as the brightness of all pixels “White” at the center of display area on optimum contrast.

Note 7: Luminance Uniformity is defined as follow:

Active area is divided into 9 measuring areas (Refer Fig. 2). Every measuring point is placed at the center of each measuring area.

$$\text{Uniformity (U)} = \frac{\text{Minimum Luminance(brightness) in 9 points}}{\text{Maximum Luminance(brightness) in 9 points}}$$

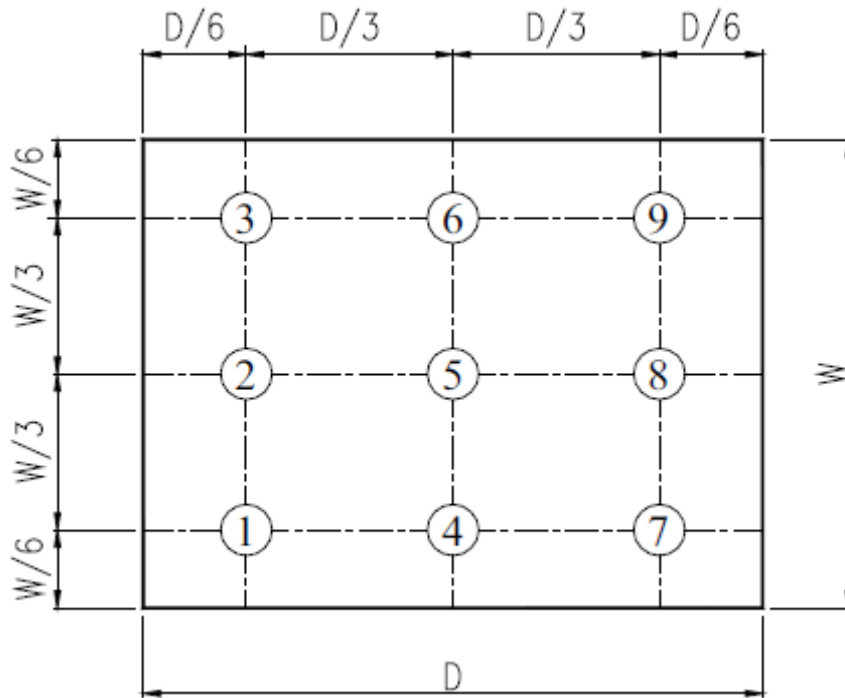

Fig. 2 Definition of uniformity

10. Environmental / Reliability Tests

No	Test Item	Condition	Judgment criteria
1	High Temp Operation	Ts=+70°C, 96hrs	Per table in below
2	Low Temp Operation	Ta=-20°C, 96hrs	Per table in below
3	High Temp Storage	Ta=+80°C, 96hrs	Per table in below
4	Low Temp Storage	Ta=-30°C, 96hrs	Per table in below
5	High Temp & High Humidity Storage	Ta=+40°C, 90% RH 96 hours	Per table in below (polarizer discoloration is excluded)
6	Thermal Shock (Non-operation)	-20°C 30 min~+70°C 30 min, Change time:5min, 10 Cycles	Per table in below
7	ESD (Operation)	C=150pF, R=330Ω · 5points/panel Air:±8KV, 5times; Contact:±4KV, 5 times;	Per table in below
8	Vibration (Non-operation)	Frequency range:10~55Hz, Stroke:1.5mm Sweep:10Hz~55Hz~10Hz 2 hours for each direction of X.Y.Z.	Per table in below
9	Shock (Non-operation)	60G 6ms, ±X,±Y,±Z 3times, for each direction	Per table in below
10	Package Drop Test	Height:60 cm, 1 corner, 3 edges, 6 surfaces	Per table in below

INSPECTION	CRITERION(after test)
Appearance	No Crack on the FPC, on the LCD Panel
Alignment of LCD Panel	No Bubbles in the LCD Panel No other Defects of Alignment in Active area
Electrical current	Within device specifications
Function / Display	No Broken Circuit, No Short Circuit or No Black line No Other Defects of Display

11. Precautions for Use of LCD Modules

11.1 Safety

The liquid crystal in the LCD is poisonous. Do not put it in your mouth. If the liquid crystal touches your skin or clothes, wash it off immediately using soap and water.

11.2 Handling

- A. The LCD and touch panel is made of plate glass. Do not subject the panel to mechanical shock or to excessive force on its surface.
- B. Do not handle the product by holding the flexible pattern portion in order to assure the reliability
- C. Transparency is an important factor for the touch panel. Please wear clear finger sacks, gloves and mask to protect the touch panel from finger print or stain and also hold the portion outside the view area when handling the touch panel.
- D. Provide a space so that the panel does not come into contact with other components.
- E. To protect the product from external force, put a covering lens (acrylic board or similar board) and keep an appropriate gap between them.
- F. Transparent electrodes may be disconnected if the panel is used under environmental conditions where dew condensation occurs.
- G. Property of semiconductor devices may be affected when they are exposed to light, possibly resulting in IC malfunctions.
- H. To prevent such IC malfunctions, your design and mounting layout shall be done in the way that the IC is not exposed to light in actual use.

11.3 Static Electricity

- A. Ground soldering iron tips, tools and testers when they are in operation.
- B. Ground your body when handling the products.
- C. Power on the LCD module before applying the voltage to the input terminals.
- D. Do not apply voltage which exceeds the absolute maximum rating.
- E. Store the products in an anti-electrostatic bag or container.

10.4 Storage

- A. Store the products in a dark place at $+25^{\circ}\text{C} \pm 10^{\circ}\text{C}$ with low humidity (40% RH to 60% RH). Don't expose to sunlight or fluorescent light.
- B. Storage in a clean environment, free from dust, active gas, and solvent.

11.5 Cleaning

- A. Do not wipe the touch panel with dry cloth, as it may cause scratch.
- B. Wipe off the stain on the product by using soft cloth moistened with ethanol. Do not allow ethanol to get in between the upper film and the bottom glass. It may cause peeling issue or defective operation. Do not use any organic solvent or detergent other than ethanol.

11.6 Cautions for installing and assembling

- A. Bezel edge must be positioned in the area between the Active area and View area. The bezel may press the touch screen and cause activation if the edge touches the active area. A gap of approximately 0.5mm is needed between the bezel and the top electrode. It may cause unexpected activation if the gap is too narrow. There is a tolerance of 0.2 to 0.3mm for the outside dimensions of the touch panel and tail. A gap must be made to absorb the tolerance in the case and connector.
- B. In order to make the display assembly stable and firm, DLC recommends to design some supporting at the display backside, especially for the display with tape-attached touch panel, such supporting is important and essential, or else, the display may drop-off from front after some period of time.
- C. Do not display the fixed pattern for a long time because it may develop image sticking due to the LCD structure. If the screen is displayed with fixed pattern, use a screen saver.

